

KD 225

15 LD 225

QUICK SPECIFICS

1
CYLINDER

4.8 | **3.5** @ 3600 rpm
HP | kW

10.4 @ 2400 rpm
Nm



DATA

DIMENSIONS (mm)

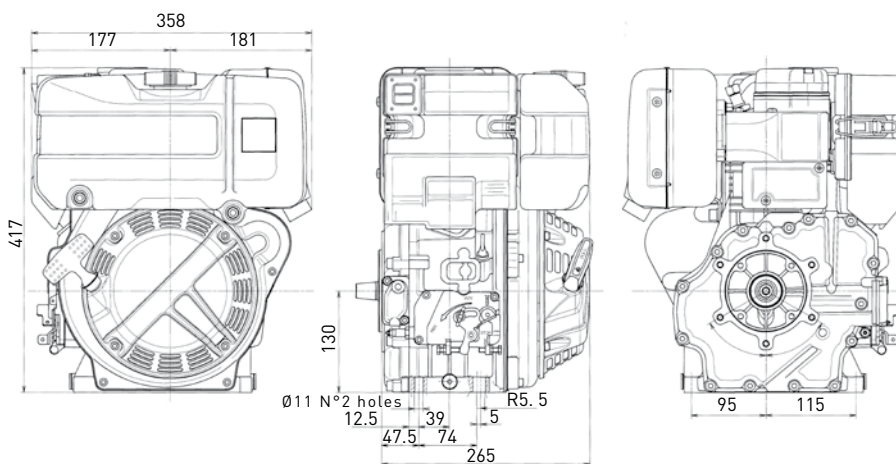

PERFORMANCE CURVES (IFN- ISO 3046 AND ISO 14396)

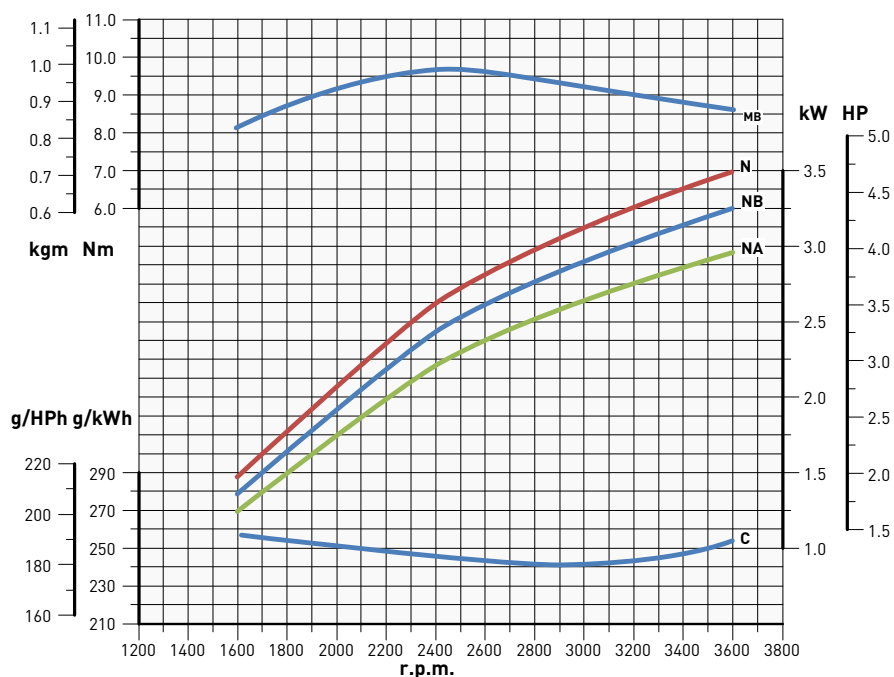

N - Power curve - 80/1269/CE E-ISO 1585

NB - Power curve - ISO 3046/1 -IFN

NA - Power curve - ISO 3046/1 - ICXN

MB - Torque curve - (NB curve)

C - Specific fuel consumption - (NB curve)

Power ratings refer to engines equipped with air filter, standard muffler, after running-in period at ambient conditions of +25°C, relative humidity 30% and 1 bar. Power levels drop by 1% every 100 m altitude and by 2% every 5°C above +25°C.