

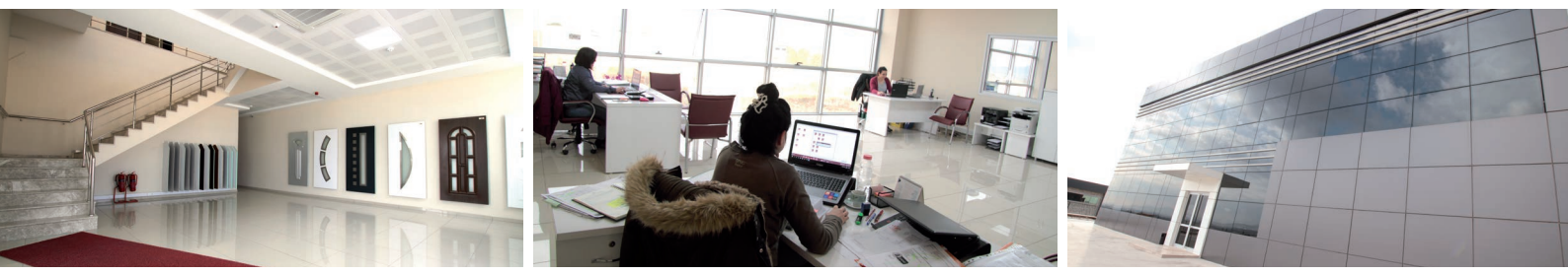

[www.apanel.com.tr](http://www.apanel.com.tr)

[www.apanel.com.tr](http://www.apanel.com.tr)



## ABOUT US / HAKKIMIZDA



DNSS PANEL LTD Company produces PVC & Aluminium Sandwich Panel and PVC & Aluminium Decorative Door Panel with experienced and Professional team since 2003. We have two Panel factories which one in Turkey and one in Romania. First factory located in IZMIR/TURKEY, 5.000m<sup>2</sup> closed totally 10.000m<sup>2</sup>, second factory located in BUCHAREST/ROMANIA, 2.500m<sup>2</sup> closed totally 5.000m<sup>2</sup>, areas with latest technology of equipment. DNSS PANEL LTD Exports 62 Countries in 5 Continent as Europe, Asia, Africa, South America and Australia. We have started Aluminium Extrusion Profile production in 2017 in ISTANBUL/TURKEY, request of our clients under the AAluminium brand, we offer lots of sectors with 500 different moulds.



DNSS PANEL LTD ŞTİ. 2003 yılından süre gelen tecrübe ve uzman kadrosu ile PVC & Alüminyum Sandviç Panel ve PVC & Alüminyum Dekoratif Kapı Paneli üretimi yapmaktadır. Türkiye'de ve Romanya'daki iki fabrikamız ile müşterilerimize hizmet vermekteyiz. İzmir'de 5.000 m<sup>2</sup> kapalı, toplam 10.000m<sup>2</sup>, Bükreş'te 2.500 m<sup>2</sup> kapalı toplam 5.000 m<sup>2</sup> tesislerimizde en son teknoloji kullanılarak üretilen ürünler Avrupa, Asya, Afrika, Güney Amerika ve Avustralya da bugüne kadar toplam 5 kıta ve 62 ülkeye ihraç edilmiştir. Müşterilerimizin talepleri doğrultusunda 2017 yılından itibaren de İstanbul'da Alüminyum Ekstrüzyon Profil imalatına da başlanmıştır. A Alüminyum markası altında yaklaşık 500 kalıp ile birçok farklı sektöre üretim yapılmaktadır.



Compania DNSS PANEL LTD produce panel tip sandwich din PVC si Aluminiu si panel decorativ pentru usi din PVC si Aluminiu, cu o echipa profesionista si cu experienta, inca din 2003. Avem doua fabrici de panel, prima localizata in Turcia si a doua in Romania. Prima fabrica este in IZMIR/TURCIA, are o suprafata de 5000 m<sup>2</sup> acoperiti si un total de 10.000 m<sup>2</sup>. A doua fabrica este localizata in Bucuresti/Romania, cu o suprafata de 2500 m<sup>2</sup> inchisi si suprafata totala de 5000 m<sup>2</sup>. Acestea sunt dotate cu echipamente cu tehnologie de ultima generatie. DNSS PANEL LTD exporta produsele sale in 62 de tari, pe 5 continente ca Europa, Asia, Africa, America de Sud, si Australia. Am deschis si fabrica de profile extrudate din Aluminiu in anul 2017 in Istanbul/Turcia. Oferim clientilor nostrii multe modele de profil cu peste 500 matrite diferite sub brandul nostru Aaluminium.



DNSS PANEL LTD ŞTİ –это фирма с большим опытом и профессиональными кадрами, которая с 2003 года занимается производством пвх & алюминиевых сэндвич панели, пвх & алюминиевые декоративные дверные панели. Мы предоставляем наши услуги в Турции и Румынии. В городе Измир крытая площадь фабрики составляет 5.000м<sup>2</sup> и общая площадь 10.000м<sup>2</sup>, в Бухаресте крытая площадь 2.500м<sup>2</sup> и общая площадь 5.000м<sup>2</sup>, вся наша продукция производится по последней высшей технологии. Продукция экспортируется на 5 континентов, 62 страны мира – это Европа, Азия, Африка, Южная Америка и Австралия. В соответствии с потребностью наших клиентов, в 2017 году мы начали производство алюминиевого профиля по маркой Аалюминий. По алюминию мы работаем в разных секторах и имеем около 500 производственных форм.



شركة DNSS PANEL LTD شركة مصنعه الساندوتس بانل سواء من مادة البى فى سى او الالومنيوم. تصنع ايضا حشوات الابواب البيكوريه من البى فى سى او الالومنيوم. لدينا خبرة في مجال التصنيع منذ عام 2003. لدينا مصنعين الاول في مدينة انمير بتركيا والثاني في مدينة بوخارست رومانيا. إنشاء المصنع الاول في مدينة انمير بتركيا باجمالي مساحه 5000 متر مربع ومساحه تصنيعه تقدر ب 10000 متر مربع. نستخدم في مصانعنا افضل واحدمت تكنولوجيا. نحن نصدر منتجاتنا الى 62 دولة حول العالم (اوربا- آسيا-أفريقيا-أمريكا الجنوبية-استراليا). خلال عام 2017 قمنا بإنشاء مصنع سحب لانتاج مقاطعات الالومنيوم في مدينة اسطنبول التركية. دائما نقدم لعملائنا العديد من انظمة المقاطعات تناسب الجميع



DNSS PANEL LTD Company has capacity of 3.500.000 m<sup>2</sup> PVC and Aluminium Sandwich Panel, 120.000 pieces PVC and Aluminium Decorative Door Panel and 1.200.000 m<sup>2</sup> Laminated PVC and Aluminium Sheet with latest technology of machines annually.



DNSS PANEL LTD. ŞTİ. en son teknoloji makinaları ile yıllık 3.500.000 m<sup>2</sup> PVC ve Alüminyum Sandvic Panel, 120.000 adet PVC ve Alüminyum Dekortaif Kapı Paneli ve 1.200.000 m<sup>2</sup> Pvc ve Alüminyum Levha kaplama üretim kapasitesine sahiptir.



DNSS PANEL LTD are capacitatea de a produce anual 3.500.000 m<sup>2</sup> Panel PVC si Aluminu tip Sandwich , 120.000 bucati de Panel Decorativ din PVC si Aluminu pentru Usi si 1.200.000 m<sup>2</sup> foi din PVC si Aluminu laminat cu tehnologie de ultima generatie.



DNSS PANEL LTD - компания с новейшими технологиями и оборудованием имеет годовой оборот производительности 3.500.000 м<sup>2</sup> -пвх и алюминиевые сэндвич панели, 120.000 штук -пвх и алюминиевые дверные панели и 1.200.000 м<sup>2</sup> -ламинированные и алюминиевые листы.



لدينا نحن شركة DNSS PANEL LTD طاقه إنتاجه تقدر بى 3.500.000 متر مربع الليوبى فى سى والالومنيوم بائل منها 120.000 متر مربع للابواب الديكوريه من اللى فى سى والالومنيوم. 1.200.000 متر مربع لليوبى فى سى والالومنيوم الملون باستخدام أحدث تقنيات وتكنولوجيا التصنيع





## PACKING & LOADING / PAKETLEME & YÜKLEME

www.apanel.com.tr



We are able to produce different sheet and different filling materials as client special requests. We also produce and packing with best optimization non-standard products which requested different countries because of reducing the transport cost.



Standart ürünlerimizin haricinde isteğe bağlı olarak farklı levhalar ve farklı dolgu malzemeler ile de müşterilerimizin özel sandvic panel taleplerini karşılamaktayız. Ayrıca müşterilerimizin isteğine uygun olarak farklı ülkelerdeki standartlarımız dışındaki ölçülerdeki ürünler ve paketleme ile en uygun optimizasyon yapılarak minimum nakliye maliyetleriyle ürünlerimizi sevketmekteyiz.



Putem sa produce, diferite dimensiuni de foi si diferite tipuri de umplutura, la cererea speciala a clientilor. De asemenea putem sa producem si sa impachetam optim produse de dimensiuni non-standard asa cum cer diferite tari pentru a reduce costurile de transport.



Для того чтобы удовлетворить потребности клиентов, мы имеем возможность производить пvh листы различных размеров с различными наполнителями для сэндвич панелей. С наилучшей оптимизацией мы также производим продукцию и упаковку продукта вне стандарта с минимальной стоимостью доставки.



نحن دائما على استعداد لتلبية وتصنيع مجموعات مختلفة من شرائح اليو بي في سي لارضء عملائنا الكرام. نستخدم افضل التكنولوجيا الحديثة في عملية التغليف لضمان وصل بضائعنا لعملائنا كما طلبوها



Thickness 0.80 mm to 2.00 mm  
Kalınlık 0.80 mm - 2.00 mm

White Colors RAL 9016 / RAL 9010 or Requested Colors  
Beyaz Renkler RAL 9016 / RAL 9010 veya İstenilen Renklerde

Surface Sheet / Silk Matt or Glossy  
Levha Yüzeyi İpek Mat veya Parlak

Sheet Dimension / Required length and width up to **2400** mm  
Levha ölçüsü istenilen uzunlukta ve **2400** mm genişliğe kadar



Özellikleri Properties	İşleme Processing	Uygulama alanı Field of application
* Darbeye Dayanıklı * Impact resistance	* Termoform * Thermoforming	* Kaynak * Welding
* Yüksek UV - ve hava dayanımı * High UV- and weathering resistance	* Kaplama * Laminating	* Vidalanma * Screwing
* Neme karşı dayanıklı * Moisture resistance	* Panç * Punching	* Boyama * Painting
* Mükemmel vakuum karakteristikleri * Excellent vacuum forming characteristics	* Kesme ve dilme * Sawing, Drilling	* İç cephe kaplaması * Interior wall facing
* İyi Kimyasal direnci * Well Chemical Resistance	* Serigrafi * Digital Printing	* İç ve Dış cephe mimarisi * Interior and exterior architecture
* Geri dönüşümlü * Recyclable		
* Sararma yok * Non-fading		
* Yangın dayanıklı * Fire resistance		





## PVC OR HPL LAMINATED SHEET / PVC VEYA HPL LAMİNE LEVHA

[www.apanel.com.tr](http://www.apanel.com.tr)

Thickness 1.30 mm to 2.00 mm

*Kalınlık 1.30 mm - 2.00 mm*

*Golden Oak / Mahogany / Nussbaum / Dark Oak / Anthracite*

*Grey / Rustic Oak / Aluminium Grey or Requested Colors*

*Altın Meşe / Mahon / Ceviz / Wenge / Anthracit Gri /*

*Rustik Mese / Alüminyum Gri veya İstenilen Renklerde*

Sheet Dimension / Required length and width up to 1300 mm

*Levha Ölçüsü İstenilen uzunlukta ve 1300 mm genişliğe kadar*



White Colors RAL 9016 / RAL 9010 or Requested Colors  
Beyaz Renkler RAL 9016 / RAL 9010 veya İstenilen Renklerde

Panel Dimensions / Panel Ölçüleri  
750x2000mm / 800x2000mm / 1000x2000mm / 1200x3000mm / 1500x3000mm / 2000x3000mm / **2400x3300mm**

Panel Thickness / Panel Kalınlığı  
20mm / 24mm / 28mm / 32mm / 36mm / 40mm / 44mm / 48mm / 52mm

Pvc Sheet Thickness / Pvc Levha Kalınlığı  
0.80mm / 0.90mm / 1.00mm / 1.10 mm / 1.2mm / 1.3mm / 1.4mm / 1.5 mm

Material / Malzeme  
PVC - XPS - PVC

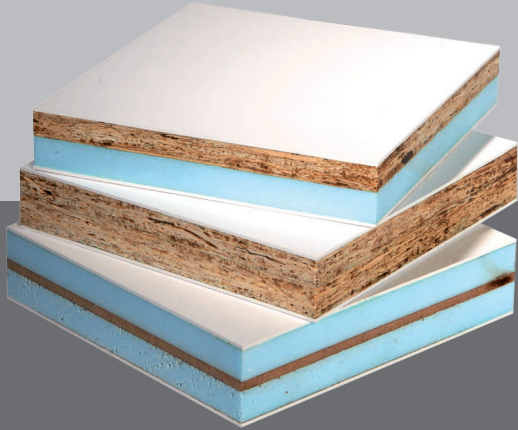
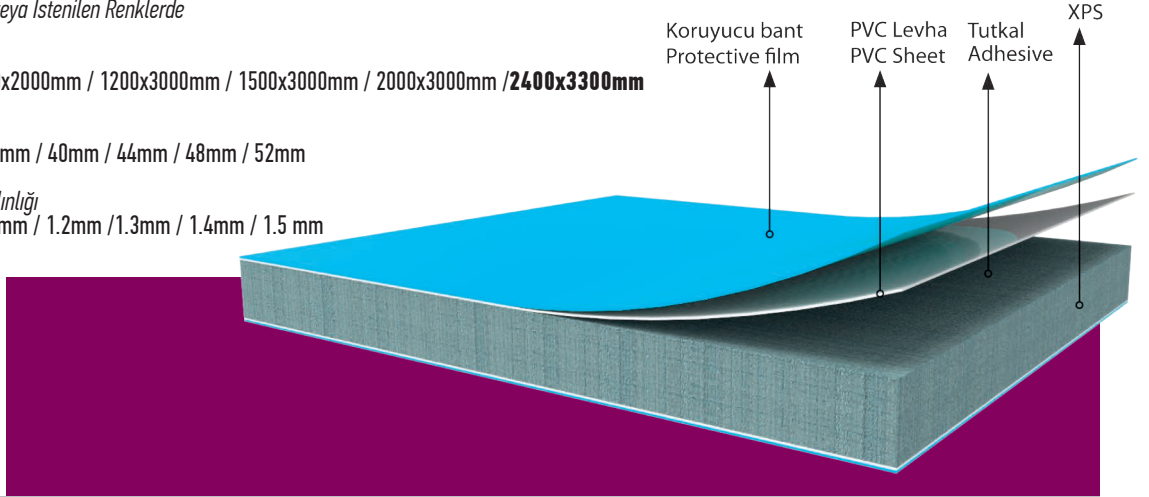

We offer different type of sheet and filling materials. We are able to make different type of panel as requested.

Farklı levhalar ve dolgu malzemeleriyle paneller üretmekteyiz. Bunların haricinde de istenilen özelliklerde farklı tiplerde paneller üretebilmekteyiz.

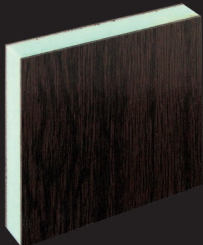

24 mm  
HPL-XPS-HPL

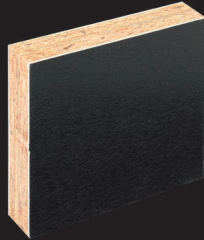

24 mm  
PVC-OSB-OSB-PVC



32 mm  
PVC-MDF-XPS-MDF-PVC



44 mm  
PVC-XPS-PLY-XPS-PVC

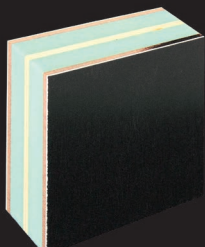

52 mm  
PVC-MDF-XPS-PLY-XPS-MDF-PVC

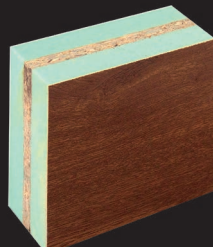

58 mm  
PVC-XPS-OSB-XPS-PVC



20 mm  
PVC-PLY-PVC

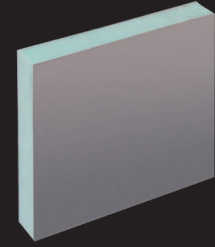

24 mm  
ALU FOIL-PVC-XPS-PVC-ALU FOIL





## PVC OR HPL LAMINATED SANDWICH PANEL

www.apanel.com.tr

PVC OR HPL LAMINATED COLORS / PVC VEYA HPL LAMİNE RENKLER  
Golden Oak / Mahogany / Nussbaum / Dark Oak / Anthracite  
Grey / Rustic Oak / Aluminium Grey or Requested Colors  
Altın Meşe / Mahon / Ceviz / Wenge / Anthracit Gri / Rustik Meşe / Alüminyum Gri  
veya İstenilen Renklerde

Panel Dimensions / Panel Ölçüleri  
800X2000mm / 1300x2000mm / 1300x3000mm

Panel Thickness / Panel Kalınlığı  
20mm / 24mm / 28mm / 32mm / 36mm / 40mm / 44mm / 48mm / 52mm

Pvc Sheet Thickness / Pvc Levha Kalınlığı  
1.30mm / 1.70mm

Malzeme / Material  
PVC FOIL - PVC - XPS - PVC - PVC FOIL

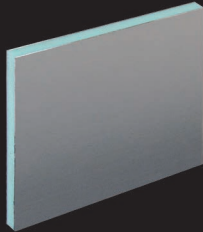
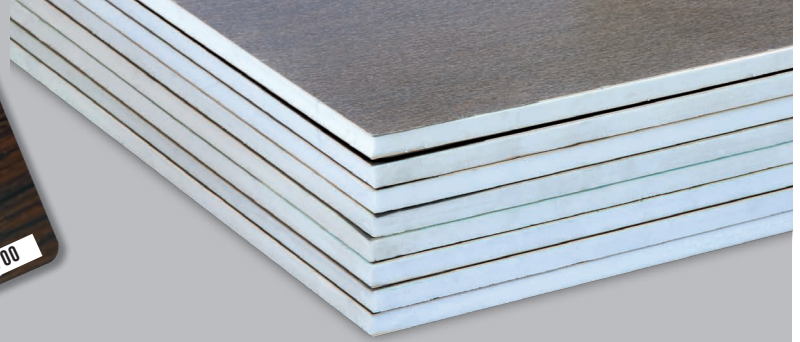
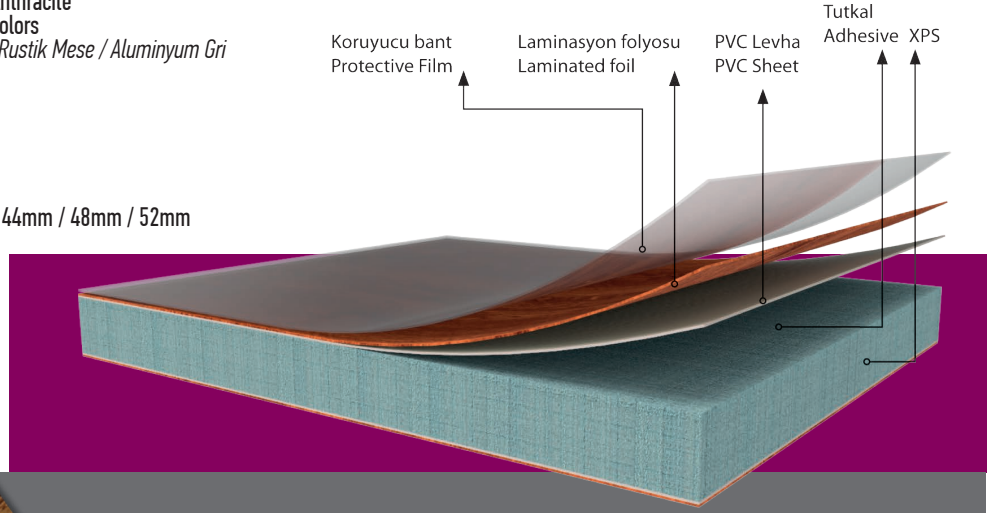

10 mm  
ALU-XPS-ALU



14 mm  
PVC-OSB-PVC

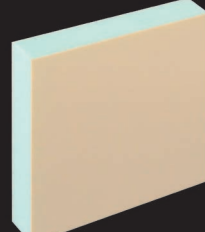

15 mm  
PVC-XPS-PVC

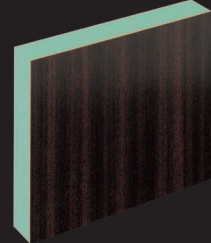

24 mm  
PVC-XPS-PVC

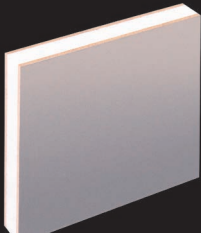

20 mm  
ALU FOIL-MDF-XPS-MDF-ALU FOIL

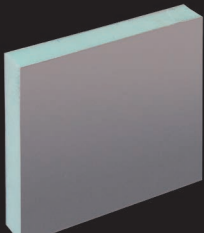

20 mm  
ALU-XPS-ALU



24 mm  
PVC-XPS-MDF-PVC



24 mm  
PVC-XPS-OSB-PVC



PVC and Aluminium Door Panels used for Exterior and Interior requests, White or Wood imitation laminated colors. We offer standard models and special request models. We give PVC or Aluminium sheet a requested shape with our machines than we add tempered or not tempered decorative glasses as clients request after that we bring them together with XPS insulation boards, if requested we are able to give them more strength with additional materials like MDF, OSB or Aluminium sheet.



*Dış meknlarda ve iç meknlarda kullanılmak üzere beyaz ve ağaç desen kaplamalı olarak üretilen Pvc ve Alüminyum Kapı panellerimiz, PVC ve Alüminyum levhaların standart modeller yada müşterilerimizin özel modelleriyle şekillendirmesiyle üretim sürecimiz başlar. Müsterilerimizin istekleri doğrultusunda dekoratif, temperli yada tempersiz camlar ilave edilerek devam eder daha sonra dolgu malzemesi olarak xps ısı yalıtım levhaları ile birleştirilir, istenildiği takdirde mukavemet kazanması için MDF, OSB veya Alüminyum levhalar da ilave edilebilir.*



*Panel Decorativ din PVC si Aluminiu pentru Usi pentru folosirea lor in interior sau exterior, de culoare alba sau laminate cu imitatie de lemn. Oferim modele standard precum si modele speciale conform cerintelor. Taiem foile din PVC sau Aluminiu la masina, la dimensiunile cerute, apoi adaugam sticla decorativa care poate fi securizata sau nesecurizata, tot la cererea clientilor, dupa care se asambleaza cu placi din polistiren extrudat. Este posibil, la cerinta clientului, ca, pentru a mari rezistenta, sa putem adauga la asamblare materiale aditionale ca MDF, OSB sau foi de Aluminiu.*



*Пвх и алюминиевые дверные панели используются для внутренних и наружных потребностей помещений, имеют цветовую гамму белого цвета или ламинацию имитации дерева. Мы предлагаем стандартные и специальные модели. Мы предаем пвх или алюминиевому листу требуемую форму благодаря нашим машинам, добавляем закаленное или не закаленное стекло по желанию клиента и соединяем их вместе с XPS теплоизоляционными панелями. По запросу клиента для того чтобы панель была более прочной мы можем использовать дополнительный материал как МДФ, OSB или алюминиевый лист.*



*الابواب الديقورية من البى فى سى او الالومنيوم يمكنكم استخدامها داخليا او خارجيا سواء اللون الابيض او الملونه نضع البى فى سى والالومنيوم ونضع الزجاج الديقورى والفوم سويا بامكاننا اضافة شرائح الام دى اف او الاخشاب*

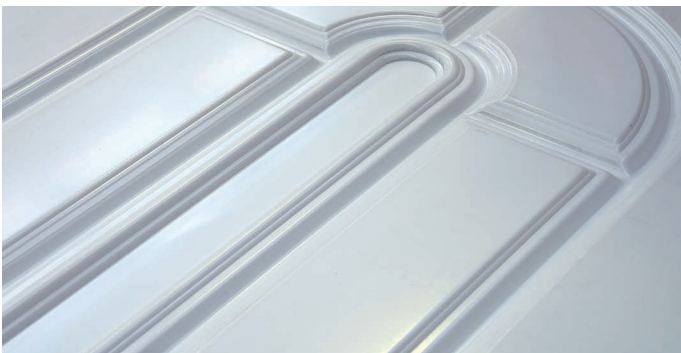



PVC AND ALUMINIUM DOOR PANEL  
*PVC VE ALÜMİNYUM KAPI PANELLERİ*

[www.apanel.com.tr](http://www.apanel.com.tr)

FLAT SERIES



10810



10240 - Nussbaum



11340



10110

10240

10370

10430

10530

10610

10700



10810

10930

11040

11130

11230

11340

11440



11510

11620

11730

11830

11910

12050

12120



12210

12340

12420

12520

12640

12750

12830



12940

13020

13120

13230

13350

13440

13570

a

panel

PVC AND ALUMINIUM DOOR PANEL / PVC VE ALÜMİNYUM KAPI PANELLERİ

INOX SERIES



21840 - A.Grey



21410



20710



20110

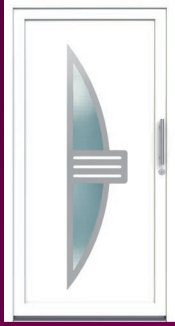

20220



20330



20430

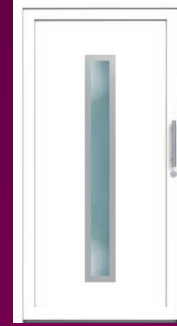

20510



20610

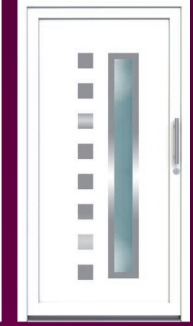

20710

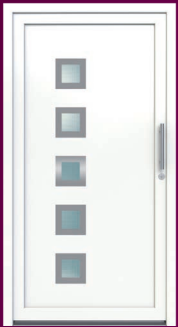

20850



20910



21010



21140



21220



21310



21410



21540

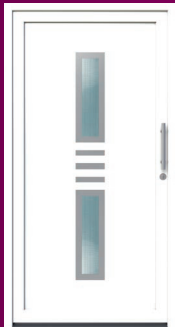

21620



21720



21840



21940

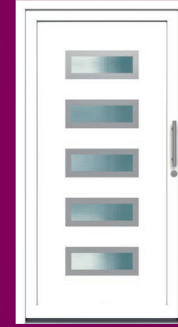

22050

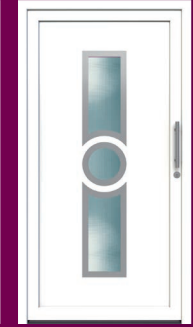

22130

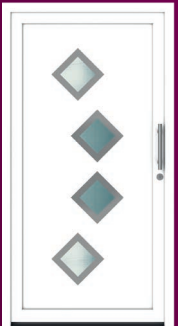

22240



22310



22440

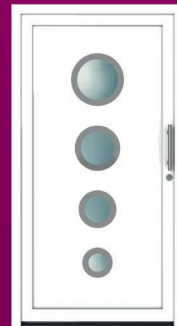

22540



22620

*Special Inox Series*

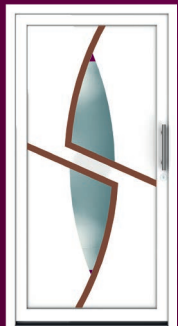

22720



22820

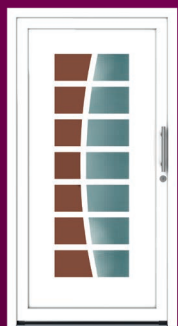

22970



23050



23130



Bronze Hairline



Bronze Mirror



Gold Hairline



Gold Mirror

THERMO SERIES



30260 - G.Oak



31331

31331 H



31411 - D.Oak



30100 30100 H 30110 30111 30111 H 30130 30131 30131 H 30132



30150 30151 30151 H 30152 30200 30260 30300 30310



30311 30312 30400 30420 30440 30460 30480



30500 30510 30511 30600 30650 30650 H 30651 30700



30720 30721 30722 30800 30820 30821 30821 H 30822





30900



30920



30921



30921 H



30922



31000



31020



31021



31040



31041



31042



31060



31061



31061 H



31062

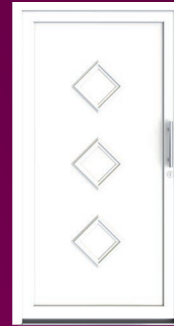

31100



31130



31200



31220



31221



31240



31241



31241 H



31242



31260

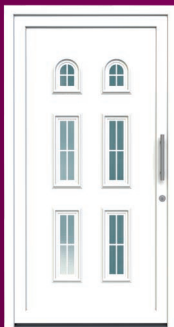

31261



31261 H



31262



31300



31310



31311



31330



31331



31331 H



31332



31400



31410



31411



31412



31540

MODERN SERIES  
THERMO INOX SERIES



40340 - Light Red

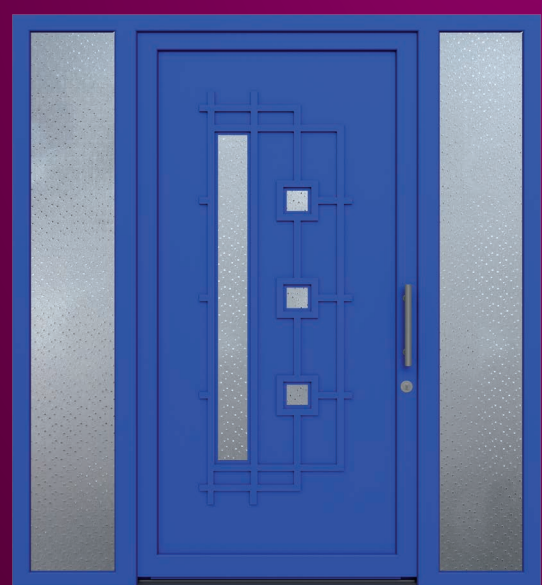

50240 - Dark Blue



40250 - A.Grey



50110

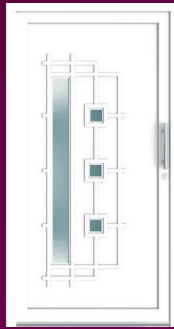

50240



50310



50410

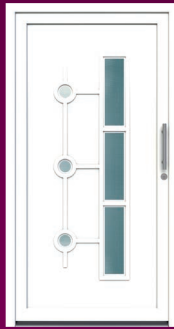

50560

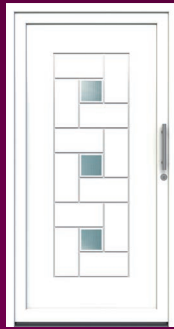

50630



50740



50850

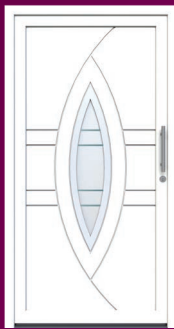

50910



51040



51120



51210

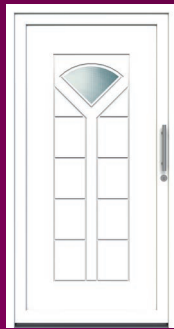

51310



51410



51550



51640

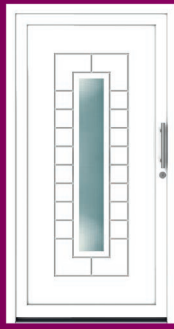

51710



51810



51910

*Thermo Inox Series*



40130



40250



40340



40410



40510

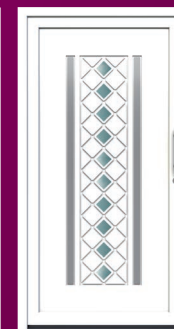

40610

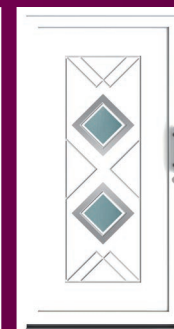

40720



40830



40910



41010



41110

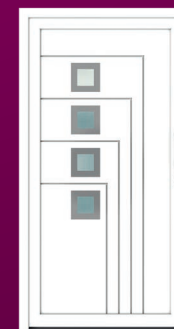

41240



41320

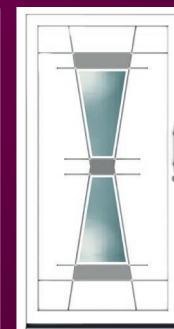

41420

ALUMINIUM AND PVC PRESS SERIES



60411



60512



60131 - G.Oak



60111



60151



60222



60311

SMALL PANEL SERIES

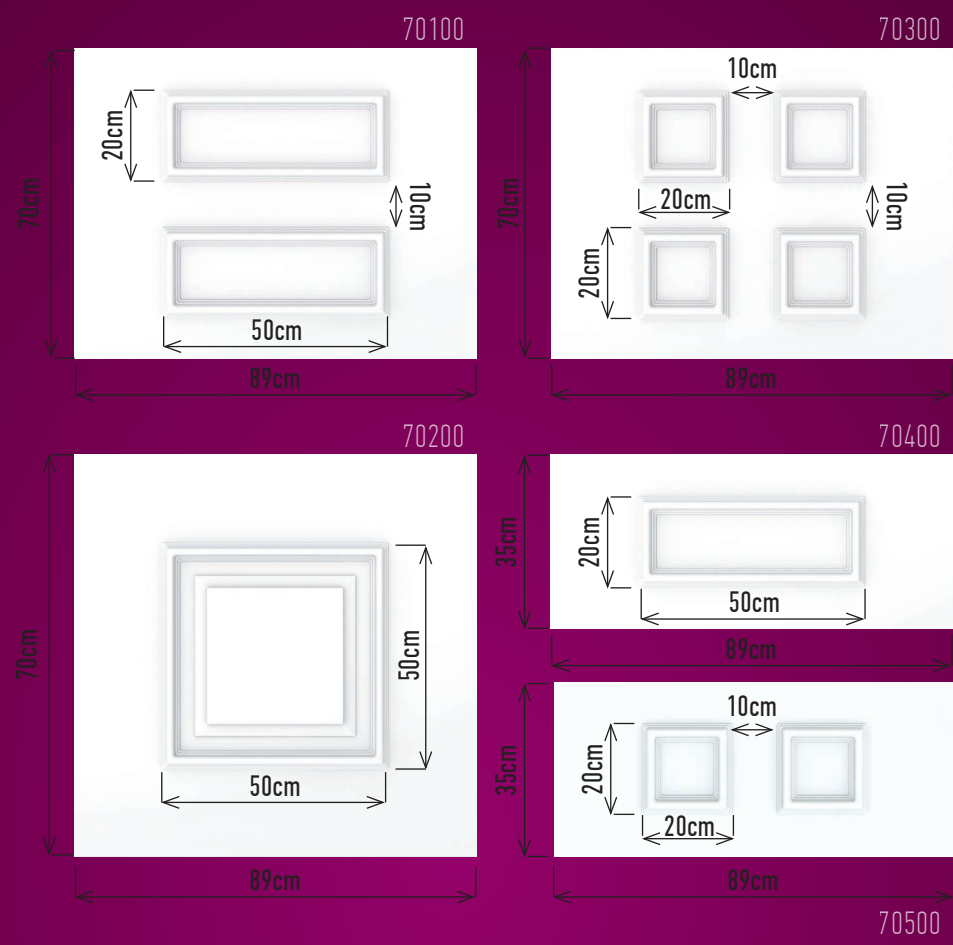

SPECIAL GLASS

STANDARD GLASS



DECORATIVE BAR TYPES / DEKORATİF BARLAR



## INTERIOR DOOR

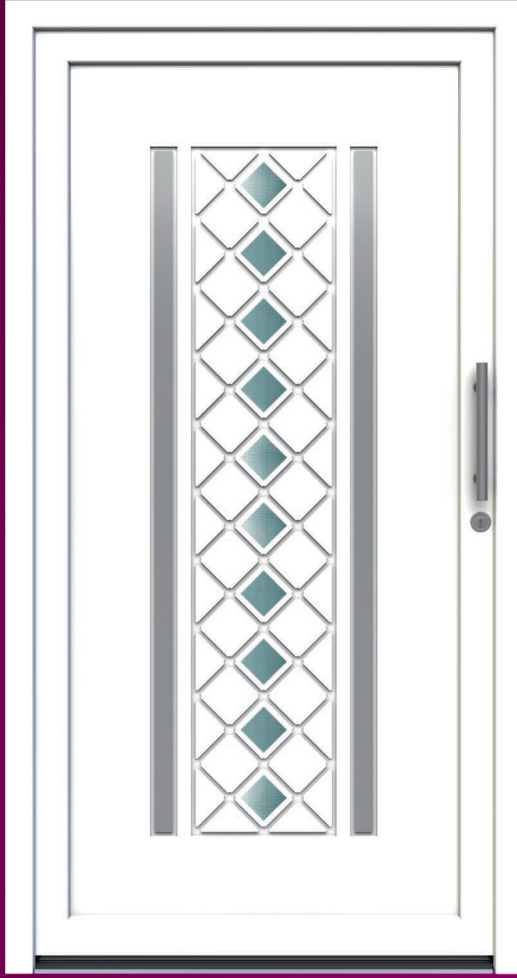

INT 40610

- Easy to Assamble  
*Kolay Montaj*
- Color Options  
*Geniş Renk Seçenekleri*
- Water Resistant  
*Suya ve Neme Dayanıklı*
- Long Life  
*Boya ve Bakım Gerektirmez*
- Impact Resistance  
*Darbeye Dayanıklı*
- Anti Bacterial  
*Anti Bakteriyel*



100 Lük Kasa / 100 mm Frame

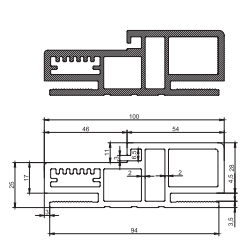

120 Lük Kasa / 120 mm Frame

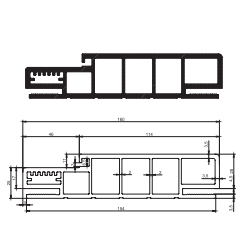

140 Lük Kasa / 140 mm Frame

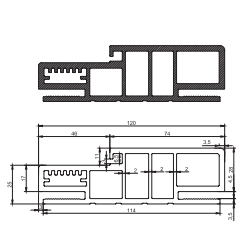

160 Lük Kasa / 160 mm Frame

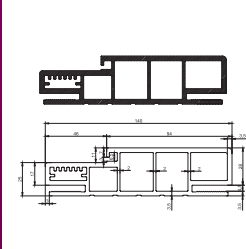

200 Lük Kasa / 200 mm Frame

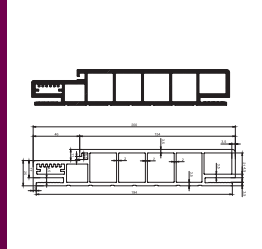

45x90 Pervaz / 45x90 Case

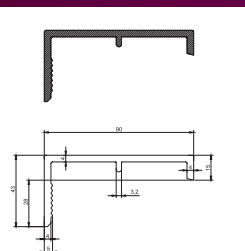

45x90 Pervaz Oval / 45x90 Case Oval

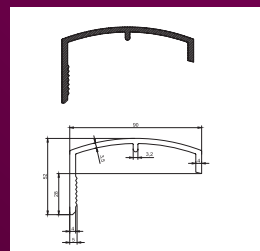

73x90 Pervaz / 73x90 Case

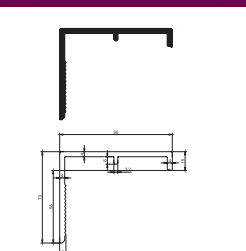

38x75 Pervaz / 38x75 Case

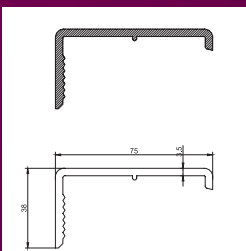

38x90 Pervaz / 38x90 Case

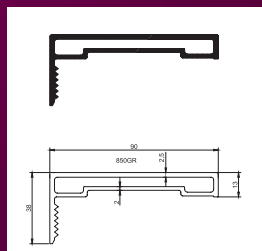



INT 50310

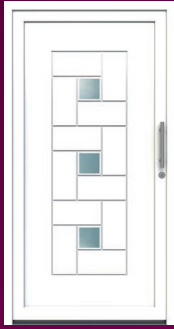

INT 50630

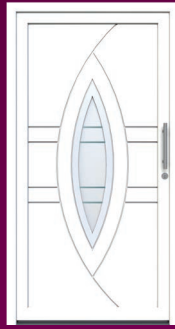

INT 50910



INT 51120

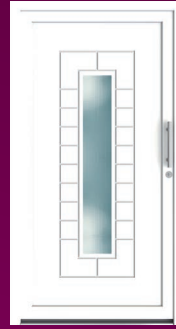

INT 51710



INT 51810

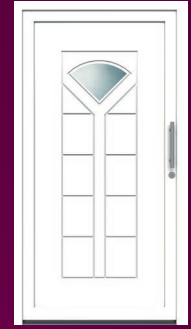

INT 51310



INT 50300

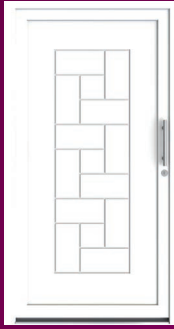

INT 50600

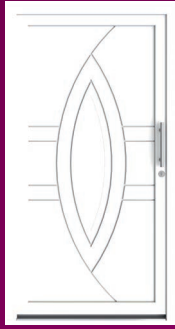

INT 50900



INT 51100



INT 51700



INT 51800

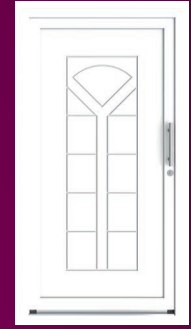

INT 51300



INT 40130



INT 40250



INT 40340

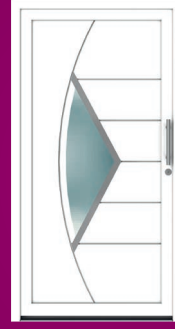

INT 41010



INT 41110

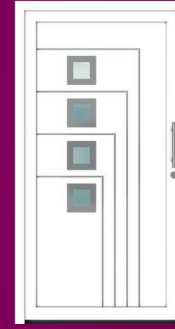

INT 41240

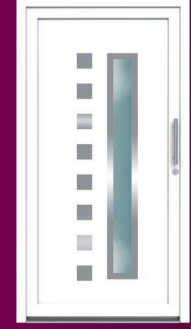

INT 20710



INT 40100



INT 40200



INT 40300

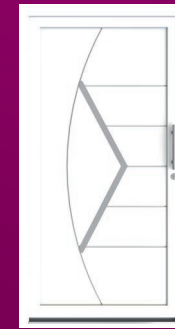

INT 41000



INT 41100

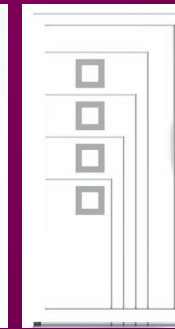

INT 41200



INT 20700



INT 20910



INT 21720



INT 21940

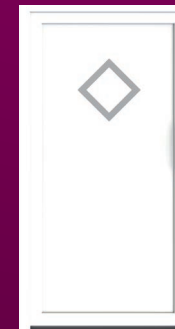

INT 20900



INT 21700



INT 21900



INT 40600

## MOST PRACTICAL PLISSE SCREENING SYSTEM *DÜNYANIN EN PRATİK PLİSE SİNEKLİĞİ*





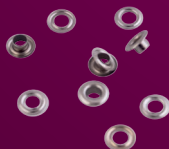
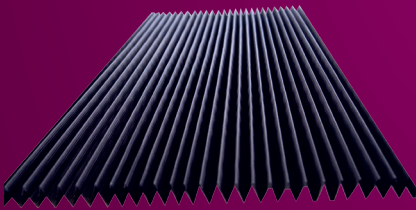
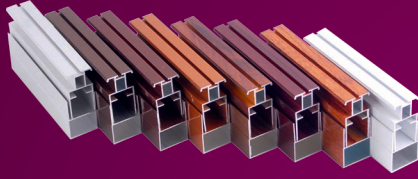

- EASY TO FIX & UNFIX LESS TRANSPORT COST  
DÜŞÜK MALİYETLE KARGO İMKANI
- ONLY ONE FRAME AND ONE SASH PROFILE  
TEK KASA VE TEK KANAT PROFİLİ İLE İMALAT İMKANI
- LESS STOCK COST  
DÜŞÜK STOK MALİYETİ
- ALL RAL COLORS IS AVAILABLE  
TÜM RAL RENK SEÇENEKLERİ İLE HER TALEBE CEVAP VEREBİLME
- TIRNAKSIZ KASA PROFİLİ İLE RAHAT HAREKETLİ TÜL
- BİTMİŞ ÜRÜNÜN İP AYARI BOZULMADAN DEMONTE

■ STOCK COLORS / STOKTAKİ RENKLER

- |                        |              |
|------------------------|--------------|
| * RAL 9016 WHITE       | * MAT ANODIC |
| * RAL 9001 CREAM       | * GOLDEN OAK |
| * RAL 8003 LIGHT BROWN | * NUSSBAUM   |
| * RAL 8014 DARK BROWN  | * DARK OAK   |
| * RAL 7016 ANTHRACITE  | * MAHOGANY   |
| * RAL 7039 QUARTZ GREY |              |

- ONLY TWO TYPE OF ACCESORIES  
İKİ TİP AKSESUARDAN PRATİK VE HIZLI ÜRETİM
- ADJUSTING FROM PVC CORNER  
KÖŞE TAKOZUNDAN İP AYARI
- İKİ TİP AKSESUARDAN PRATİK VE HIZLI ÜRETİM
- PİM VE TEKERİ TAKILMIŞ KANAT TAKOZU
- FIRST QUALITY POLYESTER MESH
- HIGH TEMPERATURE AND LOW TEMPERATURE RESISTANCE
- 2 YEAR GUARANTEE
- BİRİNCİ SINIF %95 POLYESTER TÜL
- 110 gr/m
- UZUN SÜRELİ KAT HAFIZASI
- SOĞUK VE SICAĞA KARŞI YÜKSEK DAYANIM
- 2 YIL GARANTİ
- EASY ADJUSTABLE ROPE
- A PLİSE SİNEKLİKLERDE İP STOPLAMASI GEREKMEZ
- TEK SEFERDE İKİ İP MONTESİ
- İP KOPMA YAŞANMAZ
- PVC LAMA WITH DOUBLE SIDE TAPE FOR REINFORCEMENT
- INOX SNAPS NO RUST
- LONG LIFE FOR ROPE
- POT YAPMAYAN VE DÜZGÜN GÖRÜNTÜ SAĞLAYAN PVC ŞERİT
- İPİN GEÇTİĞİ NOKTALARDA PASLANMAZ PULLU KUŞGÖZÜ
- İP DEFORMESİ OLMADAN UZUN SÜRE KULLANINIM

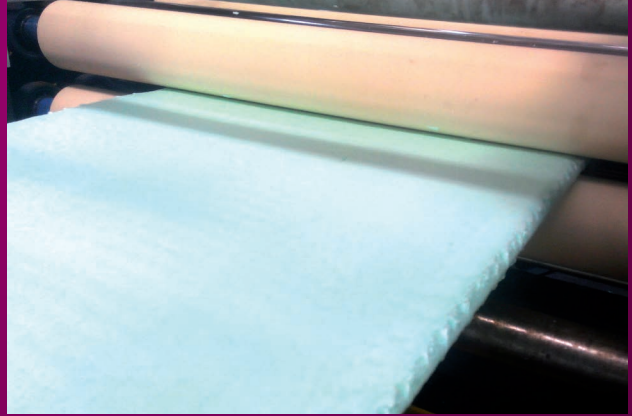

Yoğunluk (kg/m <sup>3</sup> )	26-30	28-32
Çalışma Sıcaklığı	-50 C +75 C	
Isı İletkenlik Kat. (W/m k)	<0,030 +- %5	
Yangına Dayanımı	E SINIFI	
Basma Mukavemeti CS (10/Y)	100< x >300	
Tam Daldırma İle Su Emme	wl (t) <1,5%	
Düffüzyon İle Su Emme	WD (V) 5%	
Buhar Düffüzyon Katsayısı	100 - 200	
Lineer Isısal Genleşme Katsayısı	<0,07	
Kapilarite	Yoktur	

Thickness Kalınlık	Width Genişlik	Length Uzunluk
18 mm	600 - 750	2000 - 3000
21 mm	600 - 750	2000 - 3000
22 mm	600 - 750	2000 - 3000
29 - 80 mm	600 - 750	2000 - 3000

- 500 DIFFERENT STANDARD MOULDS
- SPECIAL REQUESTED PROFILES
- ALL RAL COLORS & ANODIZED
- 4.800 TONS ANNUAL CAPACITY
- INDUSTRIAL SOLUTIONS

- 500 FARKLI STANDART KALIP
- KİŞİYE ÖZEL PROFİL İMALATI
- BOYA VE ELOKSAL SEÇENEKLERİ
- YILLIK 4.800 TON KAPASİTE
- ENDÜSTRİYEL ÇÖZÜMLER

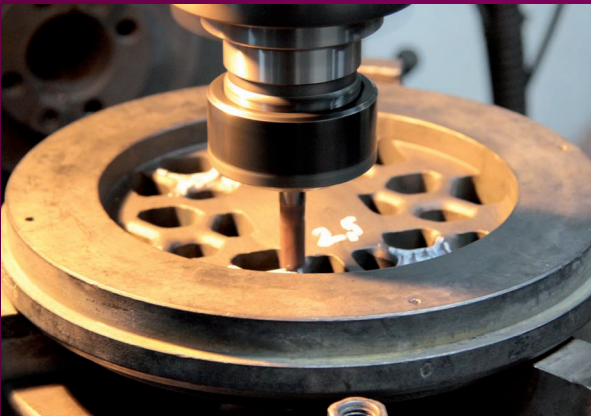
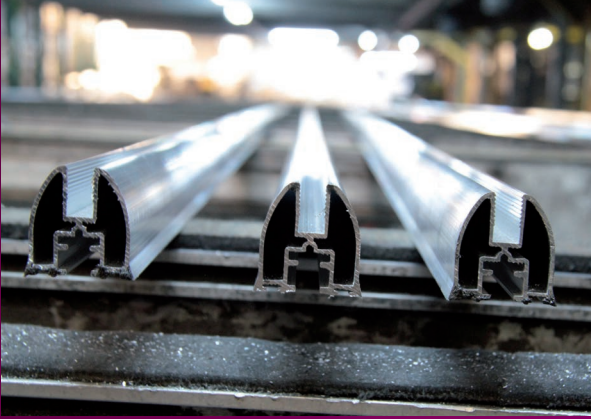



75 MM TO 300 MM WIDTH  
REQUESTED LENGTH  
ALL COLORS AND ANODIZED  
75 MM'DEN 300 MM'YE İSTENİLEN  
UZUNLUKLARDA ELOKSAL,  
TÜM RAL RENKLERİ VE TRANSFER BASKI

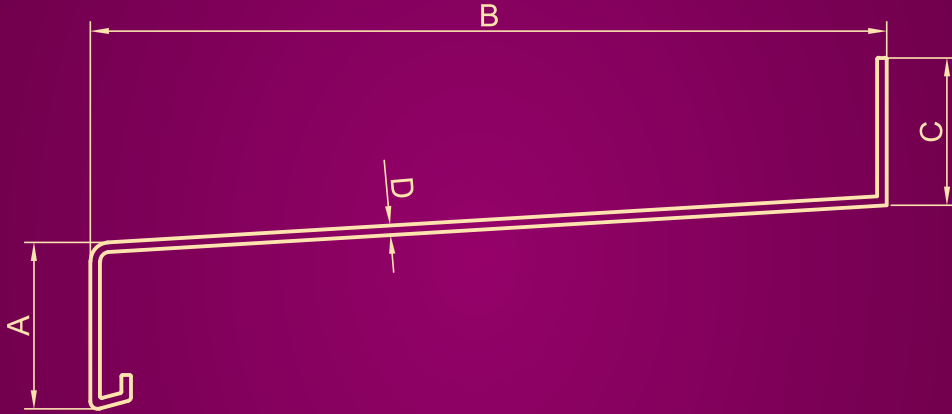

	A (mm)	B (mm)	C (mm)	D (mm)	Kg/Mt
75 mm DENİZLİK	25	75	25	1,05	0,362
110 mm DENİZLİK	25	110	25	1,10	0,483
135 mm DENİZLİK	25	135	25	1,10	0,558
150 mm DENİZLİK	25	150	25	1,20	0,658
165 mm DENİZLİK	25	165	25	1,20	0,707
180 mm DENİZLİK	25	180	25	1,35	0,851
195 mm DENİZLİK	25	195	25	1,35	0,905
210 mm DENİZLİK	25	210	25	1,40	0,995
225 mm DENİZLİK	25	225	25	1,30	0,979
240 mm DENİZLİK	25	240	25	1,35	1,072
260 mm DENİZLİK	25	260	25	1,40	1,187
280 mm DENİZLİK	25	280	25	1,80	1,567
300 mm DENİZLİK	25	300	25	2,00	1,846

## SİNEKLİK SİSTEMLERİ

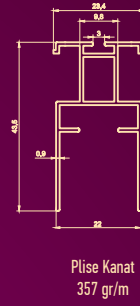
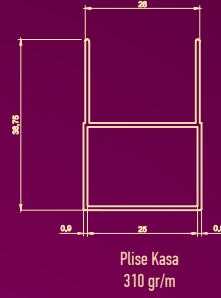
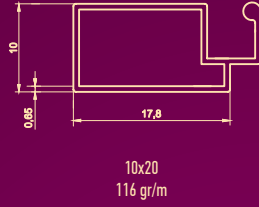
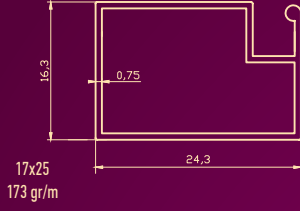

## CAM BALKON PROFİLLERİ

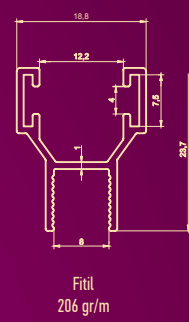
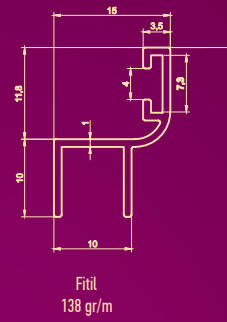
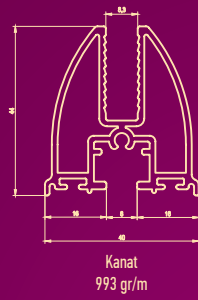
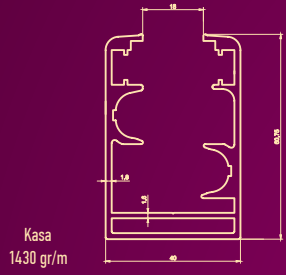

## KUTU PROFİLLERİ

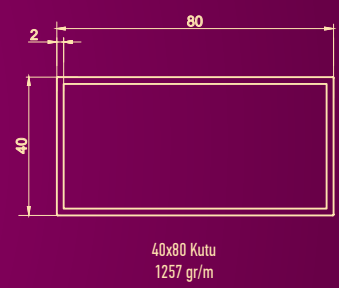
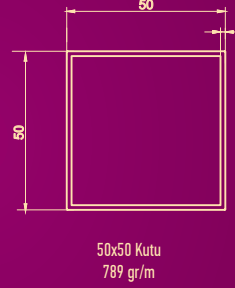
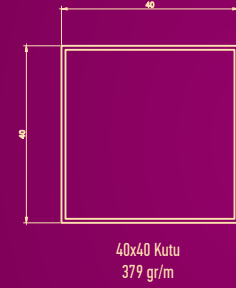
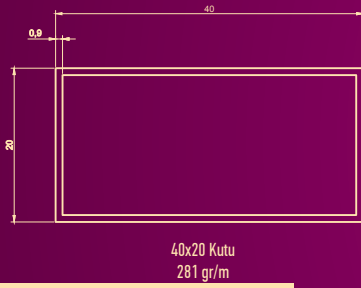

## KÖŞEBENT PROFİLLERİ

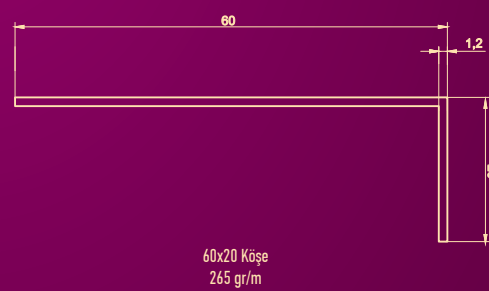
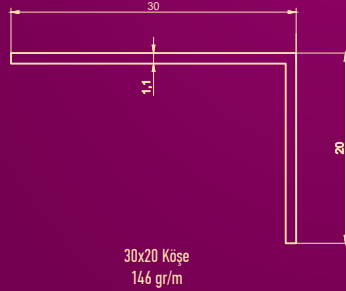
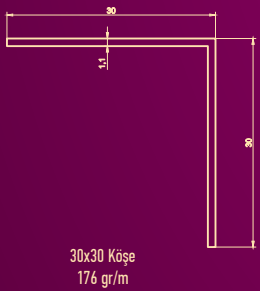

## DİĞER PROFİLLER

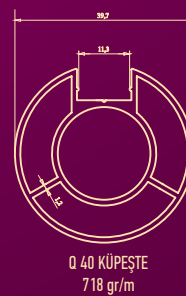
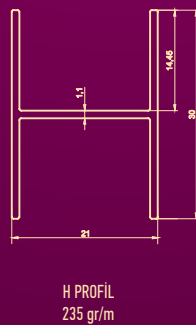
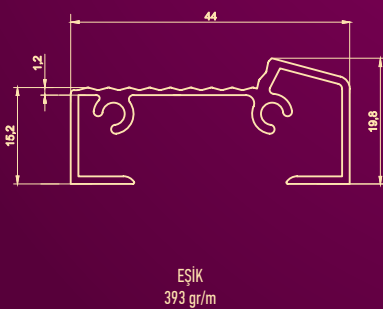



**T.C. TÜRK PATENT ENSTİTÜSÜ**  
**MARKA TESCİL BELGESİ**  
 Marka No : 2012 33478 - Ticaret - Hımet

**A PANEL**

Marka Sahibi : DNSS PANEL İMALATI SANAYİ VE TİCARET LİMİTED ŞİRKETİ  
 TÜRKİYE CUMHURİYETİ  
 Pancar OSB 3 Cad. No:2  
 Torbalı İZMİR

Emtiası : 19 , 35  
 İşisidir.

Markaların Korunması Hakkında 556 Sayılı Kanun Hükmünde Kararnameye göre 09/04/2012 tarihinde itibaren ON YIL müddetle 17/09/2013 tarihinde tescil edilmiştir.

Prof. Dr. Habib KANAN  
 Enstitü Başkanı



**British Certifications Inc.** JAS-ANZ  
 M43469910

**Registration Certificate / Tescil Belgesi**

This is to certify that the Quality Management System of  
 Bu belge ile Kalite Yönetim Sistemi belgelenmiştir:

**DNSS PANEL İMALATI SAN. VE TİC. LTD. ŞTİ.**

ORGANİZE SANAYİ BÖLGESİ MAH. 3 CAD. NO: 2  
 TORBALI / İZMİR / TÜRKİYE

Has been assessed by BCI and found to comply with the requirements of  
 BCI tarafından denetlenmiş ve aşağıdaki standartların gerekliliklerine uygunluğu görülmüştür.

**ISO 9001:2008**

The Quality Management System is applicable to:  
 Kalite Yönetim Sistemi:

**Certification Scope / Belgelendirme Kapsamı:**  
 MANUFACTURE OF PVC, ALUMINIUM AND HPL SANDWICH PANEL, PVC AND ALUMINIUM DOOR SANDWICH PANEL, U-PVC RIGID WHITE AND LAMINATED PVC, ALUMINIUM, HPL SANDWICH PANEL, PVC VE ALUMİNYUM SANDVIÇ KAPI PANEJİ, BEYAZ VE KAPLAMALI RIJİT PVC İMALATI

**Certification Calendar / Sertifikasyon Bilgileri:**

Certificate No: 12162	Issued on: 16.02.2017
Sertifika Numarası: 12162	Yayımlama Tarihi: 16.02.2017
Registered on: 16.02.2017	Expires on*: 15.02.2018
Onay Tarihi: 16.02.2017	Geçerlilik Tarihi*: 15.02.2018
Surveillance 01 on/before: 15.02.2018	
1'inci Gözetim için Son Tarihi: 15.02.2018	
Surveillance 02 on/before: 15.02.2019	
2'inci Gözetim için Son Tarihi: 15.02.2019	

\*The current certificate is valid from 16.02.2017 to 15.02.2018 subject to timely & successful completion of surveillance audits on schedule & valid until a new certificate is to be issued after such surveillance audits.  
 \*Bu belge geçerliliğini sürdürmek üzere başarılı denetim raporları ile zamanında ve başarılı şekilde denetimlerin yapılması gerekmektedir.

BCI British Certification Inc.  
 ANADOLU ULUSLARARASI BELGELENDİRME HİZMETLERİ LTD. ŞTİ.  
 Hisarözü, Akpınar Yolu No: 101 Kat:Belgelenme Hizmetleri Katı, 065 20 200 00 Ankara, Türkiye  
 www.bci-certification.com.tr | info@bci-certification.com.tr



**Certificate CE**

**CE ATTESTATION OF CONFORMITY**

Manufacture Name / İmalatçı Adı: DNSS PANEL İMALATI SAN. VE TİC. LTD. ŞTİ.  
 Address / Adres: ORGANİZE SANAYİ BÖLGESİ MAH. 3 CAD. NO: 2 TORBALI / İZMİR / TÜRKİYE

The undersigned company certifies under its sole responsibility that the item groups specified below satisfies the requirements of the GENERAL PRODUCT SAFETY DIRECTIVE 2001/95/EC which apply to it. The item groups identified below has been subject to internal manufacturing checks with monitoring of the final assessment by DNSS PANEL İMALATI SAN. VE TİC. LTD. ŞTİ.

Aşağıda tanımlanmış olan ürün grupları için 2001/95/EC GENEL ÜRÜN GÜVENLÜĞÜ DİREKTİFİNİ uygulanan ürünlerin güvenliğini yerine getirdiği ve sorumluluğuna alması konusunda beyan ederiz.  
 Aşağıda tanımlanan ürün grupları, iç denetim kontrolüne bağlı olarak DNSS PANEL İMALATI SAN. VE TİC. LTD. ŞTİ. tarafından kontrol edilmiştir.

**Description of Product(s) / Ürün Tanımı**  
 FLAT PANEL: ECO - STANDARD - CLASSIC - SUPER - SPECIAL - EXTERIOR COLORED-INTERIOR COLORED - ALUMINIUM-HPL  
 DOOR PANEL: PVC THERMO SERIES - PVC FLAT SERIES - PVC INOX SERIES - PVC MODERN SERIES - PVC THERMO - INOX SERIES - PVC SMALL SERIES - ALUM. FLAT SERIES - ALUM. INOX SERIES - ALUM. PRESS SERIES  
 U-PVC RIGID SHEET: EXTERIOR COLORED U-PVC SHEET- INTERIOR COLORED U-PVC SHEET- U-PVC RIGID SHEET-COLORED HPL SHEET - COLORED ALUMINIUM SHEET

**Related Directives / İlgili Yönetmelikler**  
 GENERAL PRODUCT SAFETY DIRECTIVE 2001/95/EC  
 GENEL ÜRÜN GÜVENLÜĞÜ DİREKTİFİ 2001/95/EC

**Regulations Applied acc. To Harmonized Standards / Uygulanan Uyumlaştırılmış Standartlar**  
 TSE K 466  
 Certificate Number : CE/1168  
 Certificate Issue Date : 16.02.2017  
 Certificate Validity : 15.02.2018

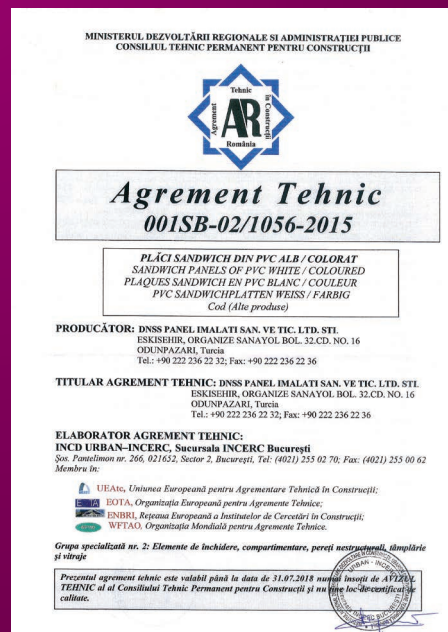

**MINISTERUL DEZVOLTĂRII REGIONALE ȘI ADMINISTRAȚIEI PUBLICE  
 CONSILIUL TEHNIC PERMANENT PENTRU CONSTRUCȚII**

**Agreement Tehnic  
 001SB-02/1056-2015**

**PLĂCI SANDWICH DIN PVC ALB / COLORAT  
 SANDWICH PANELS OF PVC WHITE / COLOURED  
 PLAQUES SANDWICH EN PVC BLANC / COULEUR  
 PVC SANDWICHPLATTEN WEISS / FARBIG  
 Căci (All products)**

**PRODUCĂTOR:** DNSS PANEL İMALATI SAN. VE TİC. LTD. ŞTİ.  
 ESKİŞEHİR, ORGANİZE SANAYİ BÖL. 32.CD. NO. 16  
 ODUNPAZARI, TÜRKİYE  
 Tel.: +90 222 236 22 32; Fax: +90 222 236 22 36

**TITULAR AGREMENT TEHNIC:** DNSS PANEL İMALATI SAN. VE TİC. LTD. ŞTİ.  
 ESKİŞEHİR, ORGANİZE SANAYİ BÖL. 32.CD. NO. 16  
 ODUNPAZARI, TÜRKİYE  
 Tel.: +90 222 236 22 32; Fax: +90 222 236 22 36

**ELABORATOR AGREMENT TEHNIC:**  
**INCĐ URBAN-INCERC, Sucursala INCERC București**  
 Șos. Pantelimon nr. 266, 021652, Sector 2, București, Tel: (4021) 255 02 70; Fax: (4021) 255 00 62

Members in:  
 UEAtc, Uniunea Europeană pentru Acordare Tehnică în Construcții;  
 EOTIA, Organizația Europeană pentru Acordare Tehnică;  
 ENTECH, Rețeaua Europeană a Instituțiilor de Certificare în Construcții;  
 WFTEAO, Organizația Mondială pentru Acordare Tehnică.

Grupul specializat nr. 2: Elemente de închidere, compartimentare, pereți nestructurali, amplășiri și vînaje

Prezentul acord tehnic este valabil până la data de 31.07.2018 asupra produsului de APĂCĂZARE TEHNICĂ al al Consiliului Tehnic Permanent pentru Construcții și nu înlocuiește certificatul de calitate.

[www.apanel.com.tr](http://www.apanel.com.tr)

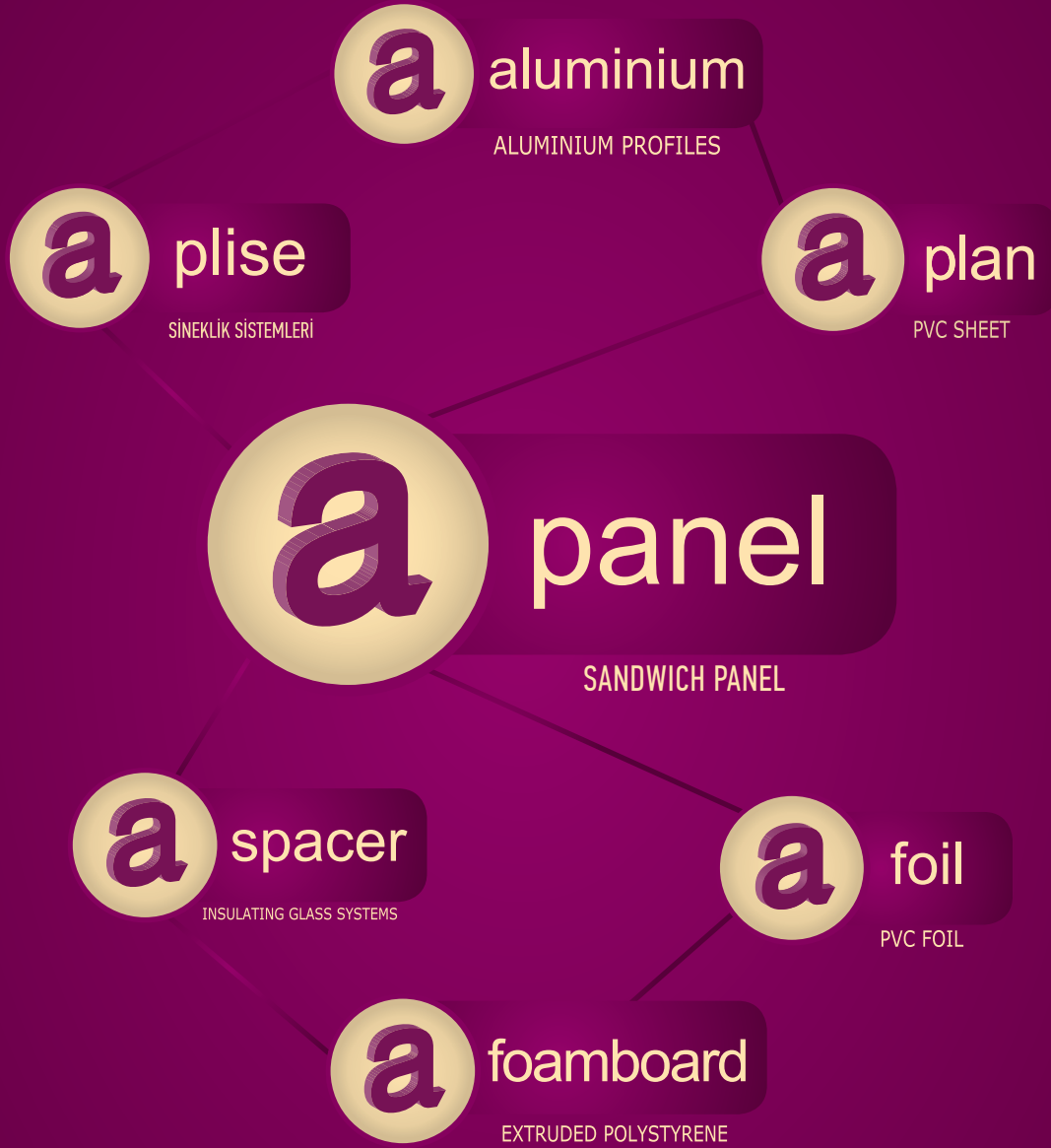

**DNSS PANEL İMALATI SAN. VE TİC. LTD. ŞTİ.**  
Pancar Organize Sanayi Bölgesi 3. Cadde No.2 Torbalı İzmir / TURKEY  
Tel : +90(232) 864 13 00 - 864 14 68 Fax : +90(232) 864 15 89  
info@apanel.com.tr - info.apanel@gmail.com  
[www.apanel.com.tr](http://www.apanel.com.tr)

[www.kosgeb.gov.tr](http://www.kosgeb.gov.tr)



**KOSGEB**

Basım Tarihi: 31.05.2019  
Tunç Çelik Amb. Tem. Ürn. Nak.  
Rekl. San ve Tic. Ltd. Şti.

istanbulgrafik  
0 222 231 10 66